

FEATURES

- Available as "HR" (high reliability) screened per MIL-PRF-19500, JANTX level. Add "HR" suffix to base part number.
- Available as non-RoHS (Sn/Pb plating), standard, and as RoHS by adding "-PBF" suffix.

MAXIMUM RATINGS

Rating	Symbol	Value	Unit
Peak repetitive forward and reverse off state voltage ⁽¹⁾ MCR225-5 MCR225-7 MCR225-9 MCR225-12	V_{DRM}, V_{RRM}	300 500 700 1000	V
On-state current RMS (all conduction angles; $T_C = 85^\circ\text{C}$)	$I_{T(RMS)}$	25	A
Average on-state current (all conduction angles; $T_C = 85^\circ\text{C}$)	$I_{T(AV)}$	16	A
Peak non-repetitive surge current (1/2 cycle, sine wave 60 Hz, $t = 8.3\text{ms}$)	I_{TSM}	300	A
Forward peak gate power	P_{GM}	20	W
Forward average gate power	$P_{G(AV)}$	0.5	W
Forward peak gate current	I_{GM}	2.0	A
Operating junction temperature range	T_J	-40 to +125	$^\circ\text{C}$
Storage temperature range	T_{stg}	-40 to +150	$^\circ\text{C}$

Note 1: V_{DRM} and V_{RRM} for all types can be applied on a continuous basis. Ratings apply for zero or negative gate voltage; however, positive gate voltage shall not be applied concurrent with negative potential on the anode. Blocking voltages shall not be tested with a constant current source such that the voltage ratings of the devices are exceeded.

THERMAL CHARACTERISTICS

Characteristic	Symbol	Max	Unit
Thermal resistance, junction-to-case	$R_{\theta JC}$	1.5	$^\circ\text{C}/\text{W}$

ELECTRICAL CHARACTERISTICS

Characteristic	Symbol	Min	Typ	Max	Unit
OFF CHARACTERISTICS					
Peak repetitive forward or reverse blocking current ($V_{AK} = \text{rated } V_{DRM} \text{ or } V_{RRM}, \text{ gate open}$)	I_{DRM}, I_{RRM}	-	-	10	μA mA
				2.0	
ON CHARACTERISTICS					
Forward on-state voltage ⁽²⁾ ($I_{TM} = 50\text{A}$)	V_{TM}	-	-	1.8	V
Gate trigger current (continuous dc) ($V_{AK} = 12\text{Vdc}, R_L = 100\Omega$)	I_{GT}	-	-	40	mA
		-	25	75	
Gate trigger voltage (continuous dc) ($V_{AK} = 12\text{Vdc}, R_L = 100\Omega, T_C = -40^\circ\text{C}$)	V_{GT}	-	1.0	1.5	V
Gate non-trigger voltage ($V_{AK} = \text{rated } V_{DRM}, R_L = 100\Omega, T_J = 125^\circ\text{C}$)	V_{GD}	0.2	-	-	V
Holding current ($V_{AK} = 12\text{Vdc}, T_C = -40^\circ\text{C}$)	I_H	-	35	40	mA
Turn-on time ($I_{TM} = 25\text{A}, I_{GT} = 50\text{mAdc}$)	t_{gt}	-	1.5	2.0	
Turn-off time ($V_{DRM} = \text{rated voltage}$) ($I_{TM} = 25\text{A}, I_R = 25\text{A}$) ($I_{TM} = 25\text{A}, I_R = 25\text{A}, T_J = 125^\circ\text{C}$)	t_q	-	15	-	μs
		-	35	-	

MCR225-5, MCR225-7, MCR225-9, MCR225-12

SILICON CONTROLLED RECTIFIERS

DYNAMIC CHARACTERISTICS

Critical rate of rise of off state voltage (Gate open, rated V_{DRM} , exponential waveform)	dv/dt	-	50	-	V/ μ s
--	-------	---	----	---	------------

MECHANICAL CHARACTERISTICS

Case:	TO-220AB
Marking:	Body painted, alpha-numeric
Pin out:	See below

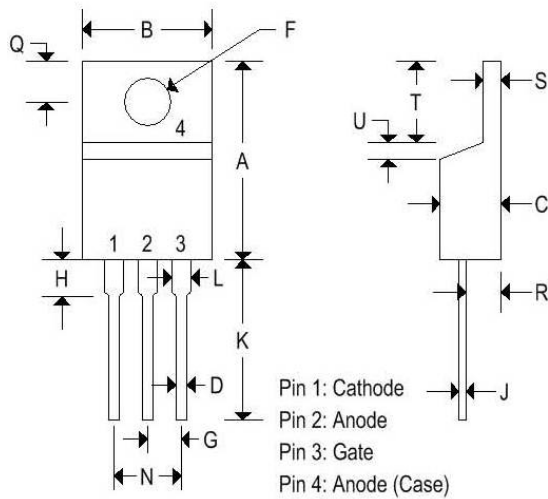

	TO-220AB			
	Inches		Millimeters	
	Min	Max	Min	Max
A	0.575	0.620	14.600	15.750
B	0.380	0.405	9.650	10.290
C	0.160	0.190	4.060	4.820
D	0.025	0.035	0.640	0.890
F	0.142	0.147	3.610	3.730
G	0.095	0.105	2.410	2.670
H	0.110	0.155	2.790	3.930
J	0.014	0.022	0.360	0.560
K	0.500	0.562	12.700	14.270
L	0.045	0.055	1.140	1.390
N	0.190	0.210	4.830	5.330
Q	0.100	0.120	2.540	3.040
R	0.080	0.110	2.040	2.790
S	0.045	0.055	1.140	1.390
T	0.235	0.255	5.970	6.480
U	-	0.050	-	1.270
V	0.045	-	1.140	-
Z	-	0.080	-	2.030

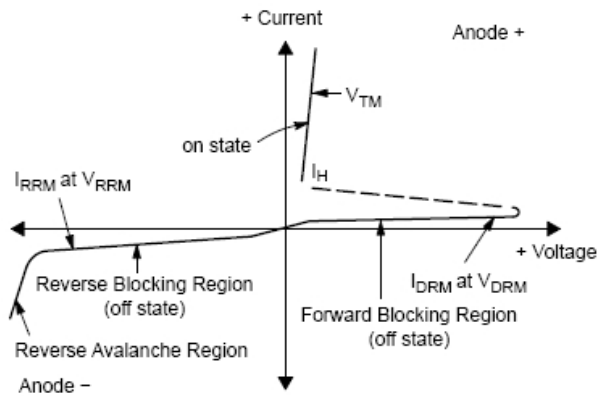

Symbol	Parameter
V_{DRM}	Peak repetitive off state forward voltage
I_{DRM}	Peak forward blocking current
V_{RRM}	Peak repetitive off state reverse voltage
I_{RRM}	Peak reverse blocking current
V_{TM}	Peak on state voltage
I_H	Holding current

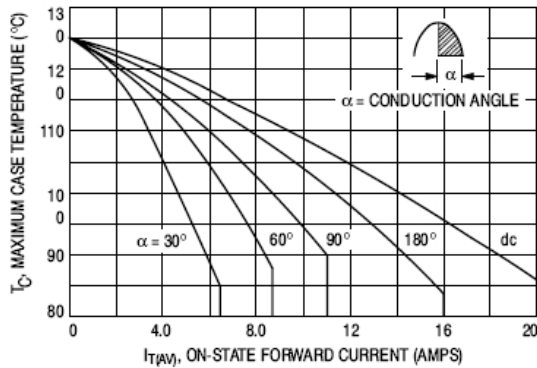

Average Current Derating

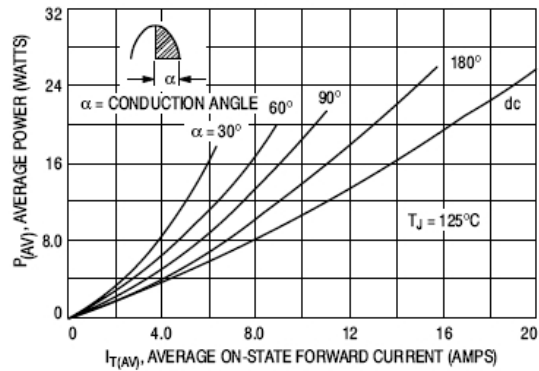

Maximum On-State Power Dissipation

MCR225-5, MCR225-7, MCR225-9, MCR225-12

SILICON CONTROLLED RECTIFIERS

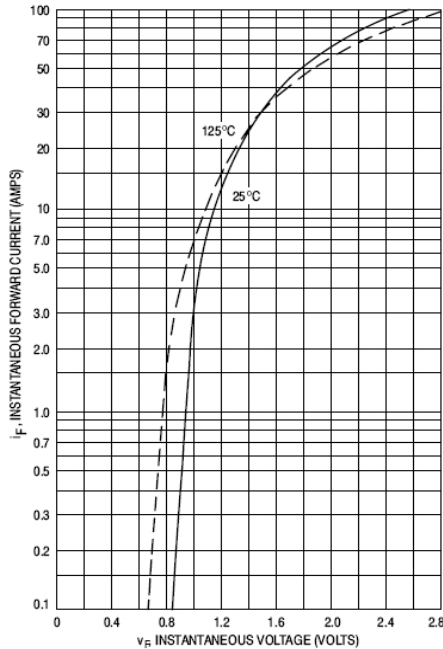

Typical On-State Characteristics

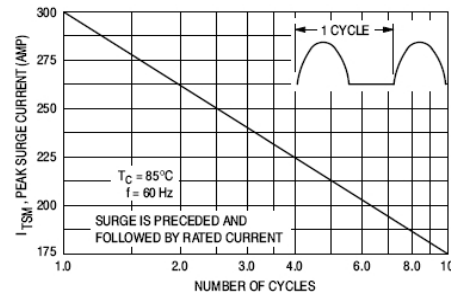

Maximum Non-Repetitive Surge Current

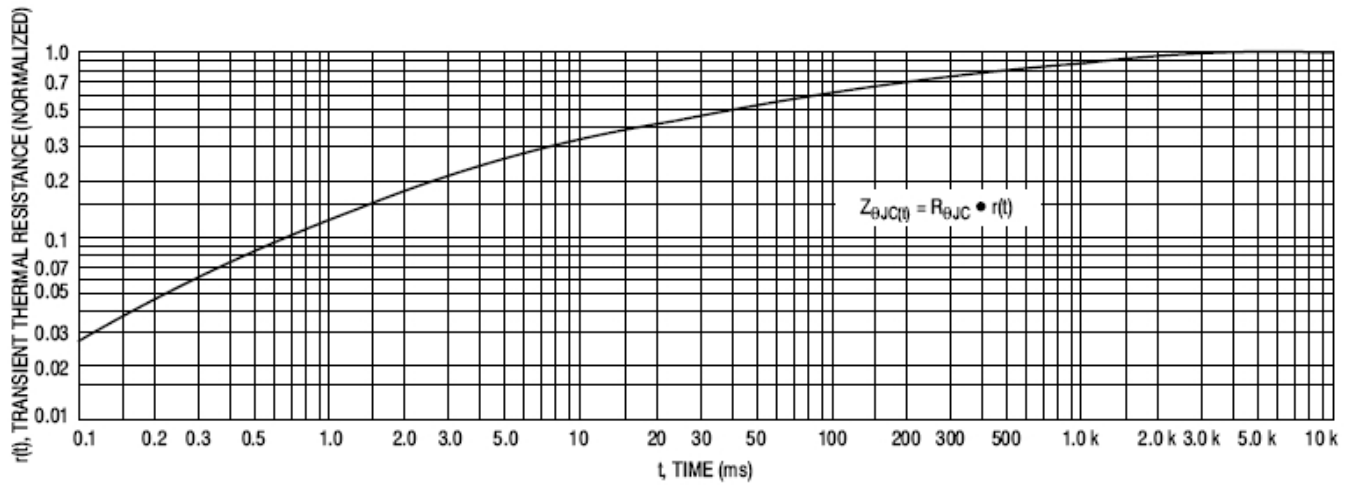

Thermal Response

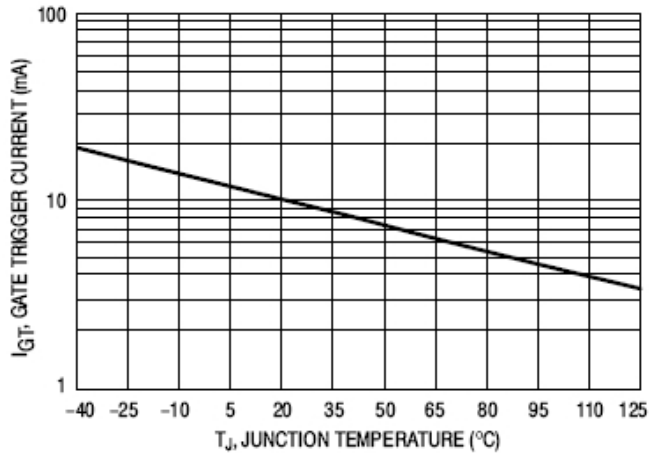

Typical Gate Trigger Current vs. Junction Temperature

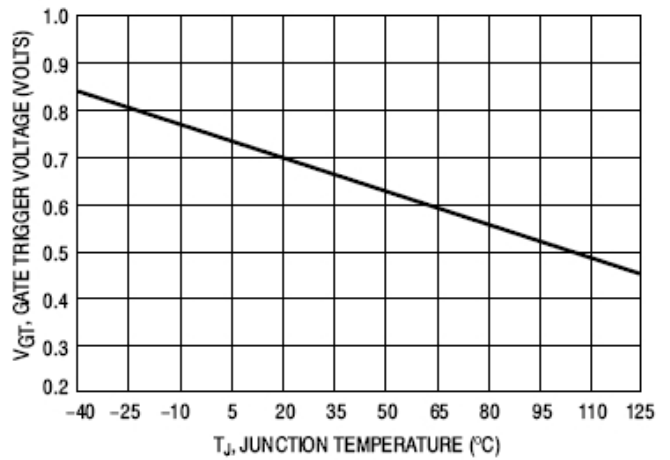

Typical Gate Trigger Voltage vs. Junction Temperature

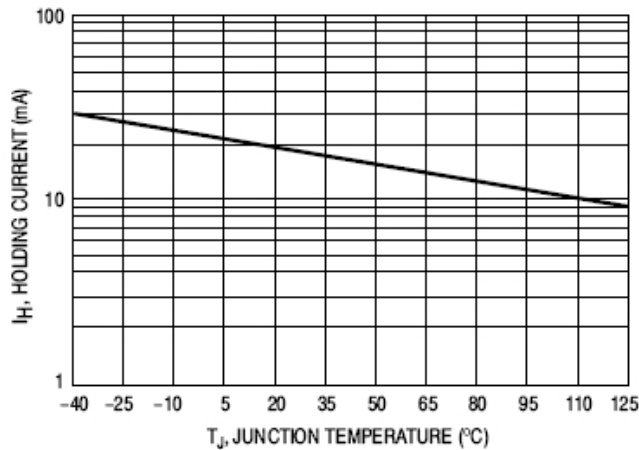

Typical Holding Current vs. Junction Temperature